

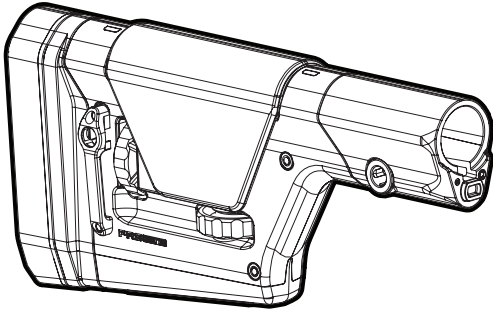

This document is subject to the Arms Export Control Act (22 U.S.C. 7228) and the International Traffic in Arms Regulations (22 C.F.R. Parts 120-130). A prior authorization or license from the U.S. State Department Directorate of Defense Trade Controls is required to export, re-export, re-transfer, or show this document to any foreign person whether in the United States or abroad.

PRS[®] GEN3 STOCK



MAG672 PRS GEN3 STOCK

INSTALLATION INSTRUCTIONS

⚠ WARNING: BEFORE STARTING, MAKE SURE THE WEAPON IS UNLOADED, THE CHAMBER IS EMPTY, AND THE SAFETY ENGAGED.

CARBINE RECEIVER EXTENSION

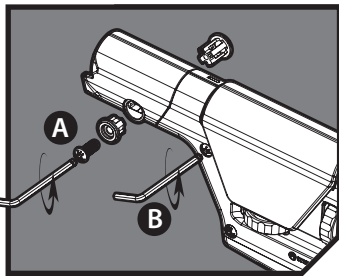

STEP 1:

A: Remove front QD Screw, Plug, and QD Sling Mount using a 1/8" hex wrench.

B: Loosen front Body Screw 1/2 turn using a 1/8" hex wrench.

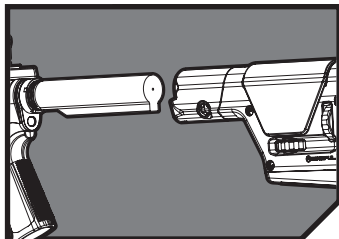

STEP 2:

Slide Stock Body over receiver extension until it is flush with the receiver end plate and castle nut.

(Designed for use with Mil-Spec sized AR15/M4 Carbine receiver extensions and Mil-Spec end plates.)

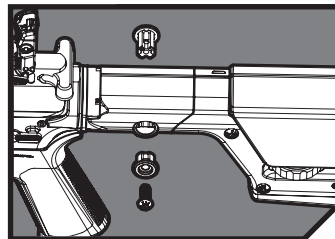

STEP 3:

Install front QD Screw, Plug, and QD Sling Mount. Torque front QD screw to 40 [in-lb] and front Body Screw until hand tight using 1/8" Hex Wrench.

Note: QD Sling Mount is reversible, can be installed on either left or right side.

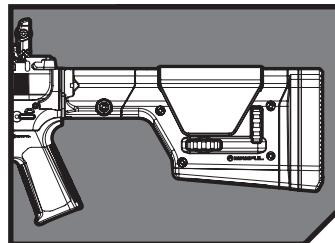

STEP 4: VERIFY INSTALL

Perform final inspection including function test per **US Army TM 9-1005-319-23&P Unit and Direct Support Maintenance Manual** to verify correct installation. If you experience any issues during installation, please contact us at www.magpul.com. Always test fire your weapon before using it in an operational environment.

RIFLE RECEIVER EXTENSION

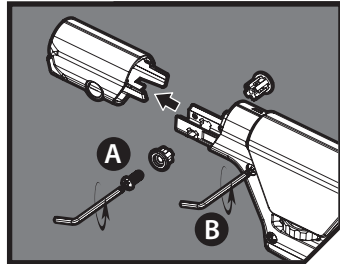

STEP 1:

A: Remove front QD Screw, Plug, and QD Sling Mount using a 1/8" hex wrench. Slide Carbine Adapter Cap forward to remove.

B: Loosen front Body Screw 1/2 turn using a 1/8" hex wrench.

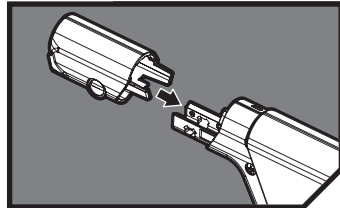

STEP 2:

Slide Rifle Adapter Cap onto Stock Body with tabs aligned.

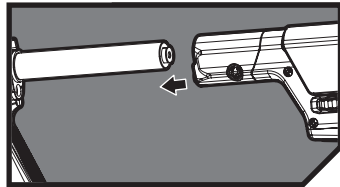

STEP 3:

Slide Stock Body over receiver extension until it is flush with the receiver, ensuring index tab and takedown detent spring are fully seated.

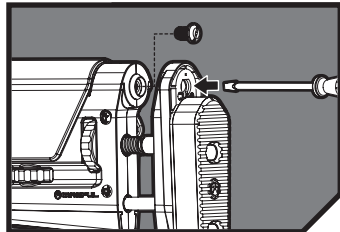

STEP 4:

Extend Butt-Plate to allow enough clearance for Vented Mounting Screw. Loosen and lower Butt-Pad per Butt-Pad Height/Cant Adjustment instructions to allow access for flat head screwdriver. Insert Vented Mounting Screw and hand tighten until fully seated.

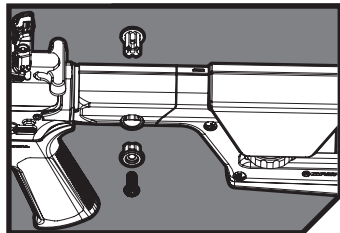

STEP 5:

Install front QD Screw, Plug, and QD Sling Mount. Torque front QD Screw to 20 [in-lb] and front body screw until hand tight using 1/8" Hex Wrench.

Note: QD Sling Mount is reversible, can be installed on either left or right side.

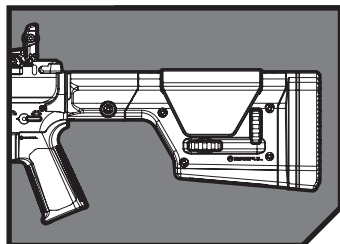

STEP 6: VERIFY INSTALL

Perform final inspection including function test per *US Army TM 9-1005-319-23&P Unit and Direct Support Maintenance Manual* to verify correct installation. If you experience any issues during installation, please contact us at www.magpul.com. Always test fire your weapon before using it in an operational environment.

ADJUSTMENTS

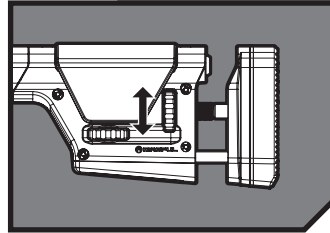

LENGTH OF PULL

Using the vertical Adjustment Knob on the rear of the stock, turn the wheel to adjust the stock to the desired LOP. Each click equals approximately 1/32" of length. Butt-Plate adjusts to a max of 1-3/8".

WARNING: DO NOT ADJUST PAST MAX LOP OR DAMAGE TO ADJUSTMENT KNOB MAY RESULT.

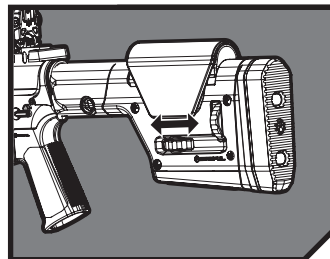

COMB HEIGHT

Using the horizontal Adjustment Knob in the middle of the stock body, turn the wheel to adjust the stock to the desired comb height. Each click equals approximately 1/32" of height. Cheek Riser adjust to a max of 3/4" above the stock body.

WARNING: DO NOT ADJUST PAST MAX COMB HEIGHT OR DAMAGE TO RECEIVER EXTENSION MAY RESULT.

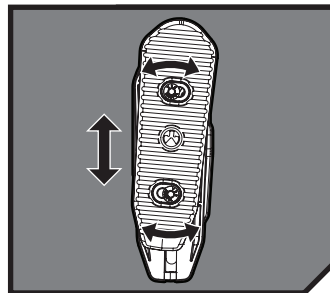

BUTT-PAD HEIGHT/CANT ADJUSTMENT

The PRS Butt-Pad can be raised or lowered 3/4" from center, and canted 5 degrees to the left or right. Loosen the two Butt-Pad Retaining Screws 1 turn, adjust to desired position, and hand tighten using a 1/8" hex wrench.

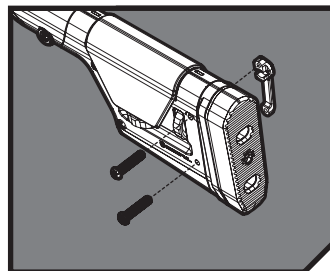

REVERSIBLE QD FOOTMAN'S LOOP

The PRS GEN3 QD Footman's Loop is reversible. Remove the two rear Stock Body Screws opposite the Footman's Loop using a 1/8" hex wrench. Reinstall in desired location and tighten Screws to 20 [in-lb].

Note: Over tightening the two rear stock body screws may impede proper function of LOP adjustment knob.